

Cabinet Installation Guide



IMPORTANT: To reduce the risk of serious or fatal injury, read and understand this entire guide before beginning any installation.



A Brand New Kitchen? Better Start Collecting Some Takeout Menus!

So you've finally decided to do it—install your own kitchen cabinets. Are you starting to have second thoughts? Don't worry, that's only normal. After all, your house will be disrupted for some time. How long? Depends on how well you have prepared.

You may even ask yourself, "Is it worth the hassle?" Those who have gone through it will tell you, "Absolutely!" A new kitchen or bath can likely add to the beauty, livability and value of your home. So here is our guide to help get you from point A to point B with less disruption to your home.

General Safety Warnings

⚠ WARNING

TO REDUCE THE RISK OF DEATH OR SERIOUS INJURY, READ AND HEED ALL WARNINGS AND INSTRUCTIONS.

USE SAFETY PRECAUTIONS AT ALL TIMES. MAINTAIN A CLEAN, WELL-ORGANIZED WORKSPACE. WEAR SAFETY GOGGLES THAT COMPLY WITH ANSI Z87.1 AND ALL PROTECTIVE EQUIPMENT RECOMMENDED BY THE MANUFACTURERS OF THE TOOLS YOU WILL BE USING.

ONLY ATTACH CABINETS TO CENTER OF WALL STUDS ACCORDING TO INSTRUCTIONS.

THIS INSTALLATION GUIDE APPLIES TO ONLY WOOD STUD CONSTRUCTION. IF YOU ARE SECURING CABINETS TO ANOTHER MATERIAL, CONSULT AN INSTALLATION PROFESSIONAL TO IDENTIFY THE PROPER FASTENERS.

NEVER USE NAILS OR DRYWALL SCREWS TO INSTALL CABINETS BECAUSE DOING SO MAY DAMAGE CABINETS OR FAIL TO PROPERLY SECURE THEM WHICH MAY RESULT IN DEATH OR SERIOUS INJURY.

Contents

General Safety Warnings.....	2
Preparation	3
Preparing Walls and Floors	3
Suggested Tool and Material List	4
Prepare Wall & Corner Wall Cabinets	5
Hang the Wall Cabinets One at a Time.....	7
Install Fillers (where applicable).....	8
Install End Panels (where applicable).....	9
Install Base Cabinets.....	9
Install Moldings (if applicable).....	11
Final Assembly and Cleanup	13
Door Hinge Adjustment	14
Drawer Head Adjustment	14
Drawer Installation.....	15
Drawer Glide Adjustments.....	15
Drawer Removal.....	16
Care and Cleaning	16

Okay, now for the stuff we have to tell you up front. Just keep in mind, if you choose to install the cabinets yourself, we really have no control over the installation—so you take on the full responsibility and liability for getting things done correctly and safely.

INSTALLATION INSTRUCTIONS – LIABILITY DISCLAIMER

When you use these instructions, you are consenting to be bound by the provisions in this paragraph. These instructions provide an illustrative method for installing certain kinds of cabinets. The instructions are not intended to address every possible contingency that might be encountered during installation or to endorse the use of any particular tools.

DISCLAIMER: WE HAS DILIGENTLY TRIED TO ILLUSTRATE AND DESCRIBE THE INSTALLATION OF THE PRODUCTS IN THIS LITERATURE CLEARLY AND ACCURATELY; HOWEVER, SUCH ILLUSTRATIONS AND DESCRIPTIONS DO NOT EXPRESS OR IMPLY A WARRANTY OF ANY KIND, INCLUDING BUT NOT LIMITED TO ANY WARRANTY THAT THE PURCHASER WILL BE ABLE TO OBTAIN A PARTICULAR RESULT, OR THAT THE PRODUCTS OR INSTRUCTIONS ARE MERCHANTABLE, OR FIT FOR A PARTICULAR PURPOSE, OR THAT THE INSTALLED PRODUCTS WILL NECESSARILY CONFORM TO THE ILLUSTRATIONS OR DESCRIPTIONS OR DIMENSIONS. THESE INSTRUCTIONS DO NOT ENLARGE OR OTHERWISE MODIFY THE LIMITED WARRANTY RECEIVED WHEN YOU PURCHASED YOUR CABINETS, IF ANY. WE HEREBY EXPRESSLY DISCLAIMS ALL WARRANTIES AND ALL LIABILITY FOR ANY CLAIMS FOR INJURY OR DEATH RELATED TO OR BASED UPON THE USE OF THESE INSTALLATION INSTRUCTIONS AND ANY INSTALLATION INSTRUCTIONS OTHERWISE PROVIDED. WE ARE NOT RESPONSIBLE FOR ANY INACCURACIES, OMISSIONS OR TYPOS IN THIS GUIDE.

The Secret is the Preparation

Before You Get Started...

If you're planning to do it yourself, first ask yourself a few questions.

- 1 Do you have some experience with carpentry?
- 2 Do you have your own tools?
- 3 Are you handy with a measuring tape and able to handle a drill, saw and screwdriver?
- 4 Are you experienced and qualified to do basic plumbing and electrical tasks?
- 5 Do you understand terms like miter cut, level and plumb?

If you passed this little quiz, you may be able to install your own cabinetry. However, if you're not an experienced do-it-yourselfer, you may be better off leaving this task to the pros.

Before You Begin

- 1 Check your inventory to be sure you received your entire order. If there are any missing or improper parts, contact your designer or customer service.
- 2 AWC recommends that no fewer than two people work together to install these cabinets.
- 3 Read and understand the entire installation guide prior to beginning the install.

Safety Precautions

⚠ DANGER

TO REDUCE THE RISK OF SERIOUS OR FATAL INJURY FROM FIRE, EXPLOSION OR ELECTROCUTION, IF GAS LINE OR ELECTRICAL WORK IS INVOLVED, HAVE THE WORK DONE BY A UTILITY COMPANY OR QUALIFIED SERVICE PROFESSIONAL.

TO REDUCE THE RISK OF SHOCK, EXPLOSION OR INJURY, TURN OFF ALL GAS, ELECTRICAL AND WATER CONNECTIONS PRIOR TO PERFORMING ANY WORK. SHUT OFF THE POWER TO ALL APPLIANCES AND RECEPTACLES IN THE KITCHEN, INCLUDING LIGHTS, AT THE FUSE-BREAKER BOX. USE A CIRCUIT TESTER TO MAKE SURE POWER IS OFF.

Once you have ensured that the gas, water and electric in the room are turned off, that the plumbing, gas and power supplies are properly capped, and have removed the old cabinetry and baseboards, you need to assess the room. Take special note of the floors and walls. Use a level or straightedge to determine high spots and other imperfections. Mark any bumpy or bulging areas. You may have to prep the walls and floors if things are not plumb, level and square. (Many people prefer to repaint and replace the flooring while the room is empty.) The time you spend preparing the room will ensure a smoother, easier installation of the cabinetry.

Prepare the Walls and Floors

We know that homes settle and things may not always be perfectly flat and level. But there are ways around this when installing cabinetry. Here are a few steps that will help you get off to a good start.

- 1 Locate and mark all the studs using a stud finder. (To verify the position of your studs, drive a small finishing nail into the wall in an area that will be covered up by a cabinet.)
- 2 Recheck your measurements. Make sure the cabinet drawings match the space.
- 3 Take inventory of your cabinets. Make sure you have your entire order.
- 4 Gather the tools you will need.

Continued

Suggested Tool and Material List

- ANSI Z87.1 Rated Safety Goggles
- Layout from Designer
- Framing Square
- Hammer
- Pry Bar
- Phillips and Flathead Screwdrivers
- Level
- Tape Measure
- Pencil
- Straight Edge
- Drill
- Properly Rated Extension Cord
- $\frac{7}{32}$ " Drill Bit for Pre-drilling the Hanging Rail
- $\frac{3}{32}$ " Drill Bits for Frame & Filler Attachment Pilot Holes
- Jigsaw or Table Saw
- Miter Box
- Clamps or C-Clamps
- Stud Finder
- 6' Step Ladder
- Wood Shims
- Pin Nailer
- Small Finish Nails
- 1x2 or 1x3 Furring Strips
- Scrap Lumber (for 55" Propping Stick or T-Brace)
- Circuit Tester
- #10 x $2\frac{1}{2}$ " Pan Head Screws (for wall attachment to stud)
- #8 x $2\frac{1}{2}$ " Trim Head Screws (for frame attachment)

⚠ WARNING

FAILURE TO PROPERLY SECURE THE CABINETS MAY RESULT IN SERIOUS INJURY! THE SCREWS RECOMMENDED ARE FOR INSTALLATIONS INVOLVING DRYWALL AND WOOD STUD CONSTRUCTION, NOT FOR CONCRETE OR BRICK. IF SECURING CABINETS TO ANOTHER MATERIAL, CONSULT AN INSTALLATION PROFESSIONAL TO IDENTIFY THE PROPER FASTENERS.

Step 1 Measure, Measure... and Measure Again

In order for cabinets to work properly and look right, they must be installed level, plumb and flush with each other. This is easy enough to achieve with some advanced planning.

- 1.1** First, locate the floor's highest point. In order to do this, place your level at the base of the wall, checking several places along the wall until you find the high point in the floor. Mark this spot. (Figure 1)

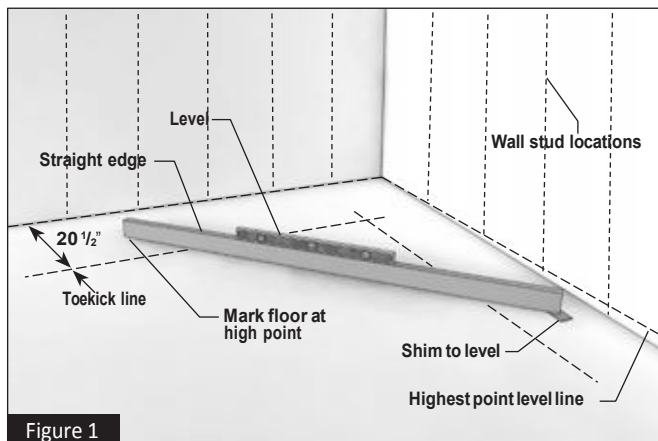

Figure 1

- 1.2** Measure up from the high point $34\frac{1}{2}$ " and draw a level line across the wall to establish the top of the base cabinets. If installing cabinets before your flooring, be sure to allow for the thickness of the material you plan to use. (Figure 2)

- 1.3** Then measure up from there another $19\frac{3}{8}$ ". This will be the baseline for the wall cabinets. (When you are finished, the wall cabinets will sit at $53\frac{3}{8}$ " above the high spot in the floor). (Figure 2) Please refer to your design elevations to verify dimensions specific to your layout

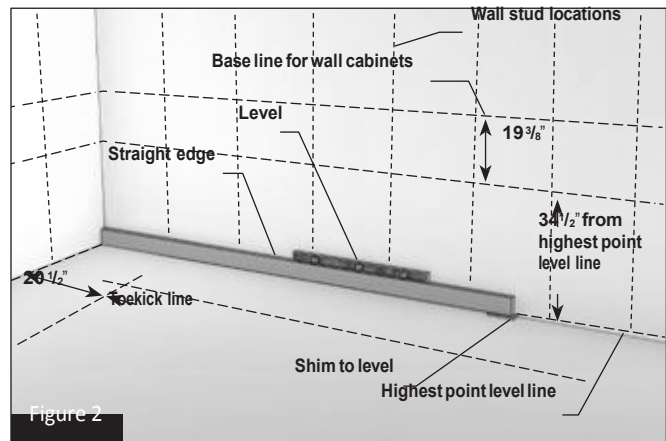
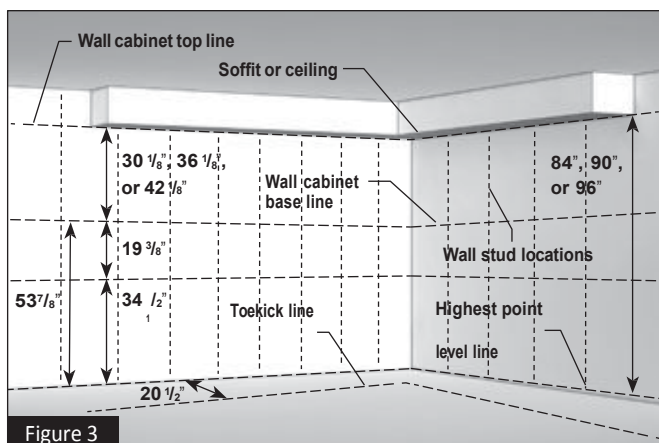

Figure 2

1.4 Now measure up from the wall cabinet base line the same distance as the height of your cabinets ($30\frac{1}{8}"$, $36\frac{1}{8}"$ or $42\frac{1}{8}"$). This will be the top line for the wall cabinets. Any non-standard height wall cabinets need to line up with this top line as well. (Figure 3)



NOTE: IF YOU HAVE A LOW CEILING OR SOFFIT, YOU MUST MAKE SURE THAT THE WALL CABINETS WILL FIT PROPERLY BETWEEN YOUR LEVEL LINE AND THE TOP.

1.5 Using the 1 x 2 or 1 x 3 furring strips, screw a support rail into the studs with 2" wood screws below the baseline you have drawn for the wall cabinets. This will help support the weight of the wall cabinets, and give you something to rest the cabinets on when installing them. Make sure your support rail (sometimes called a cleat or ledger board) is level. (Figure 4)

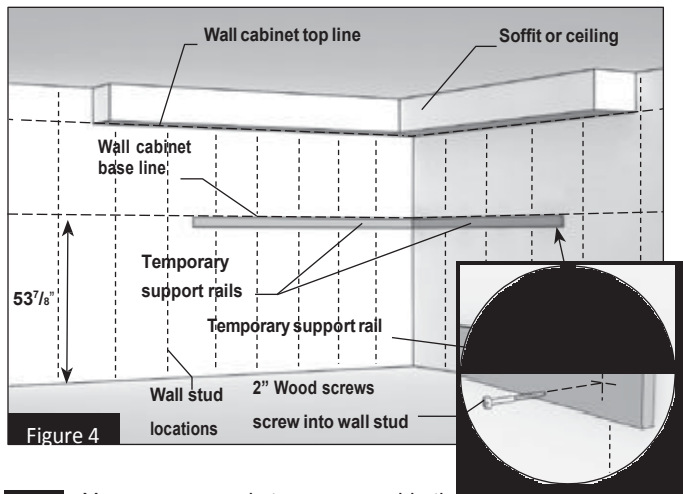

1.6 You are now ready to pre-assemble the wall cabinets.

Step 2 Prepare Wall & Corner Wall Cabinets

It is recommended that you install wall-mounted cabinets first so the base cabinets won't be in your way as you work. To begin, most people find it helpful to lay out the cabinets on the floor in position, level and plumb, and pre-assemble them before hanging.

2.1 Remove all shelves and doors. You might want to mark (or carefully stack them in position) for reinstalling later. This will make the cabinets lighter and easier to handle. (Figure 5)

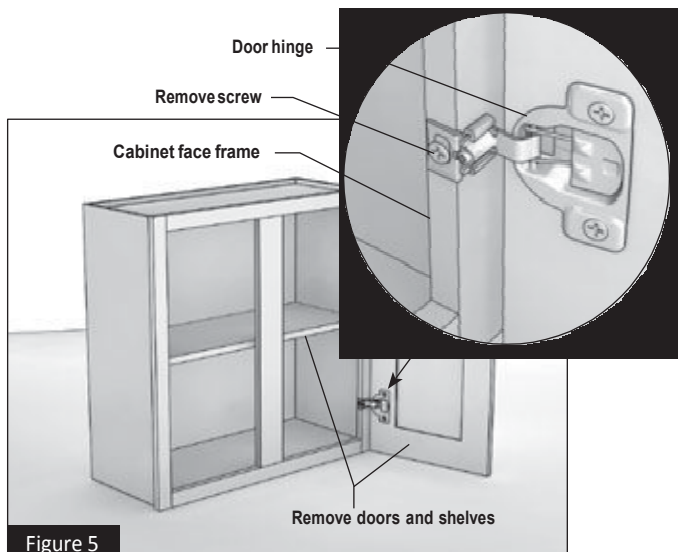

2.2 Refer to the layout provided by your designer and start with the corner cabinet (if there is one) and place it on the floor below where it is to be mounted.

NOTE: WHEN INSTALLING A BLIND WALL CABINET, MAKE SURE THE CABINET IS PULLED OUT FROM THE CORNER THE APPROPRIATE DISTANCE AS CALLED FOR IN YOUR KITCHEN PLAN. ALWAYS BE SURE TO USE A FILLER TO ALLOW FOR HINGE CLEARANCE.

2.3 One by one, align the remainder of the cabinets and fillers in position on the floor using the plan provided by the designer. (Figure 6)

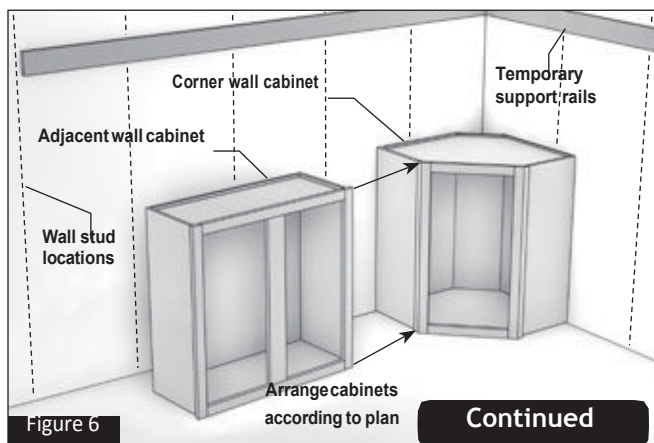

Continued

NOTE: A BLIND WALL CABINET FILLS THE VOID OF THE CORNER WITH USABLE STORAGE. THE DOOR COMES PRE-MOUNTED ON THE LEFT SIDE, BUT CAN BE MOVED TO THE RIGHT DEPENDING ON YOUR DESIGN (SEE DIAGRAM A).

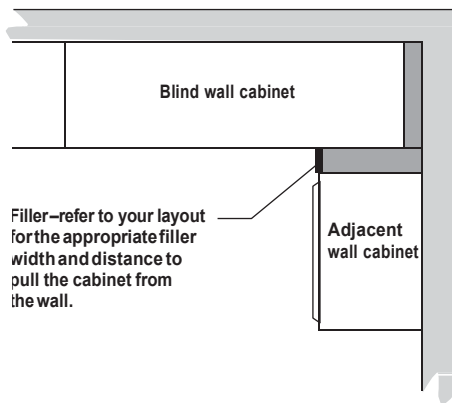

DIAGRAM A

2.4 Using a level, make sure each cabinet is level and each face frame (front of the cabinet) is flush with the adjacent cabinet. A pry bar and shims can be used temporarily to get everything level and plumb. (Figure 7)

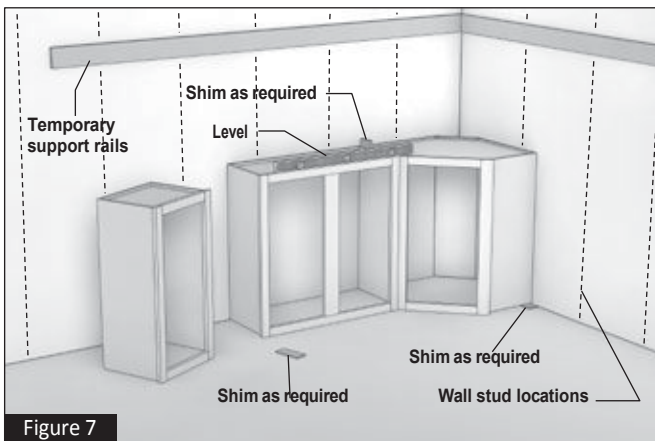

Figure 7

NOTE: IT IS PARTICULARLY IMPORTANT TO INSTALL THE FIRST CABINET LEVEL AND PLUMB, BOTH FROM SIDE-TO-SIDE AND FROM FRONT-TO-BACK BECAUSE EACH ADDITIONAL CABINET WILL BE ALIGNED WITH THE FIRST ONE.

NOTE: PLACE TALL CABINETS FOR SPACING, BUT DO NOT ASSEMBLE.

⚠ WARNING

TO PROPERLY SECURE WALL CABINETS LARGER THAN 15" WIDE, AND TO REDUCE THE RISK OF CABINETS FALLING AND CAUSING SERIOUS INJURY, USE AT LEAST 4 INSTALLATION SCREWS AND MAKE SURE THE SCREWS GO INTO THE STUDS AT LEAST 1".

2.5 In order to attach two cabinets together, you will need to clamp them together first. Then, drill a $\frac{3}{32}$ " pilot hole in three places along the hinge side of the frame. Finally, drive in the #8 x $2\frac{1}{2}$ " frame attachment (trim head) screws to join the two cabinets. (Figure 8)

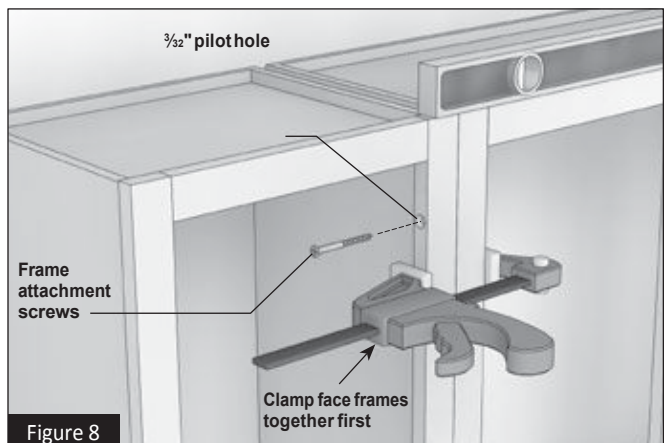

Figure 8

2.6 **IMPORTANT:** Check to make sure the frames are even and plumb.

2.7 Continue for the remainder of the cabinets and fillers following the layout provided by your designer.

2.8 Once all cabinets are pre-assembled on the floor, measure from the corner to the first stud mark and transfer the measurement to the inside of the cabinet to be installed. Repeat this step for each and every stud. Now drill $\frac{7}{32}$ " holes for mounting through the top and bottom hanging rails inside of the cabinet $\frac{3}{4}$ " down from the top and $\frac{3}{4}$ " up from the bottom. (Figure 9)

There are two hanging rails across the back of wall cabinets, one at the top and one at the bottom. Drill through both the top and bottom hanging rails at the stud location.

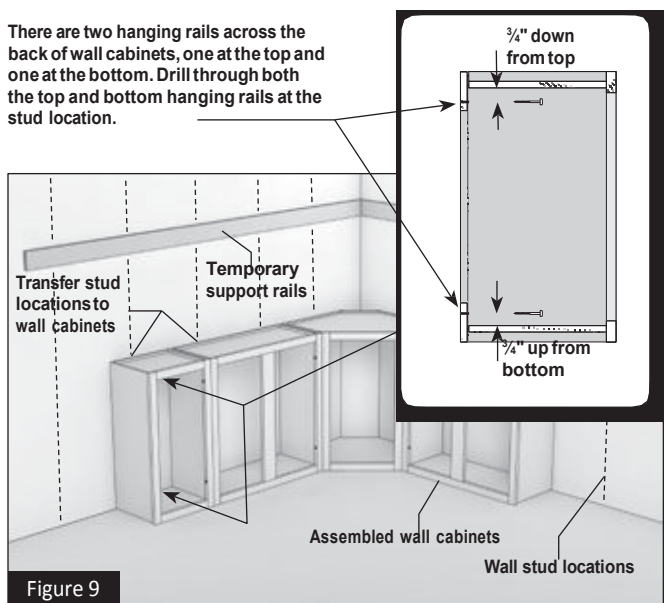

Figure 9

2.9 Fillers must also be pre-drilled and screwed into position. Refer to STEP 4—INSTALL FILLERS... for more information about measuring, cutting and installing fillers.

Step 3

Hang the Wall Cabinets One at a Time

- 3.1** Recheck the pre-assembled cabinets for level and plumb, then disassemble wall cabinets before installing.

⚠ WARNING

TO REDUCE THE RISK OF SERIOUS OR FATAL INJURY, REMOVE ALL SCREWS AND DISASSEMBLE WALL CABINETS BEFORE INSTALLING.

CABINETS MAY BE TOO HEAVY FOR ONE PERSON TO SAFELY LIFT ALONE.

THIS INSTALLATION GUIDE APPLIES TO ONLY WOOD STUD CONSTRUCTION. IF YOU ARE SECURING CABINETS TO ANOTHER MATERIAL, CONSULT AN INSTALLATION PROFESSIONAL TO IDENTIFY THE PROPER FASTENERS.

NEVER USE NAILS TO INSTALL CABINETS BECAUSE DOING SO MAY DAMAGE CABINETS OR FAIL TO PROPERLY SECURE THEM WHICH MAY RESULT IN DEATH OR SERIOUS INJURY.

TIGHTENING BACK RAILS AGAINST A CROOKED WALL WITHOUT SHIMS CAN BREAK JOINTS BETWEEN THE RAIL AND THE BODY OF THE CABINET, CAUSING IT TO FALL FROM THE WALL AND POSSIBLY RESULTING IN SERIOUS PERSONAL INJURY.

- 3.2** Start with the corner cabinet. With someone else's help, lift it into position on the support rail and use a 2x4 or T-brace at the front to prop the cabinet into place. Keep in mind, blind corner cabinets may need to be pulled out from the corner as shown in your kitchen plan. (Figure 10)

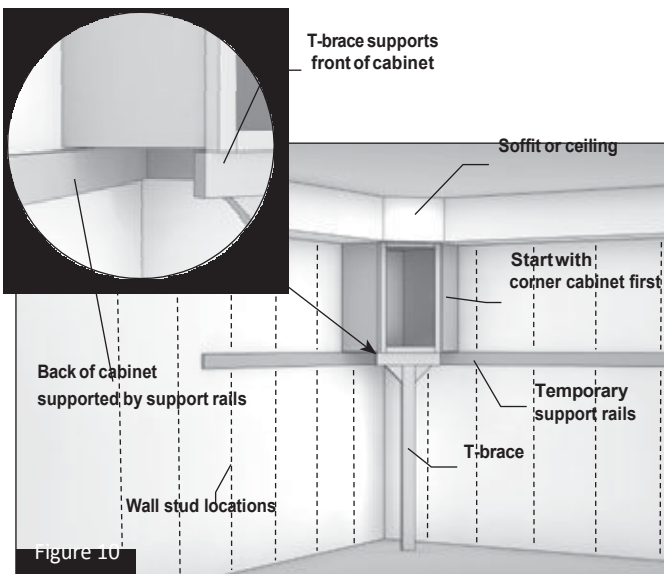

- 3.3** Fasten the cabinet to the wall with #10 x 2½" wall attachment (pan head) screws. Do not fully tighten the screws until all cabinets have been shimmed and properly positioned.

- 3.4** Next, using your level against the front of the cabinet, shim wherever necessary to make sure the cabinets are perfectly plumb (even though the walls may not be). Keep in mind, you may have to loosen the wall attachment screws slightly to shim properly.

- 3.5** Lift the adjacent cabinet into position on the support rail and brace. Using the pilot holes you created on the floor, attach the two cabinets at the face frames, making sure they are still flush when screwed together. (Figure 11)

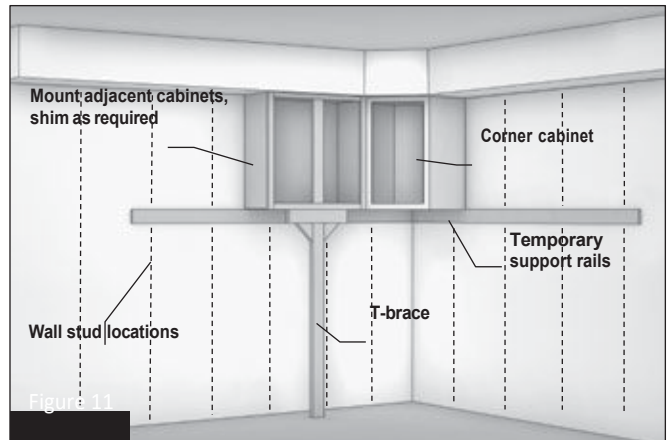

- 3.6** Once again, fasten the cabinet to the wall with #10 x 2½" wall attachment (pan head) screws. Do not fully tighten.

- 3.7** If there is a blind corner cabinet, the opening should be sealed at this point with the $\frac{1}{8}$ " panel packed inside the cabinet. Pre-drill for small finishing nails or use a pin nailer. (Figure 12)

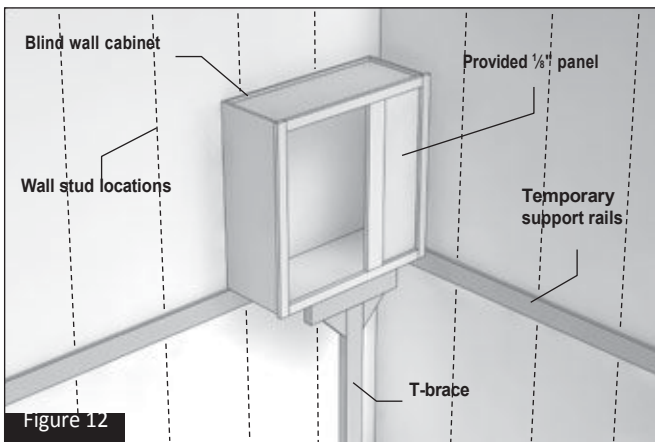

- 3.8** Continue along the walls until all cabinets are in place. If a tall or utility cabinet is part of your plan, it should be added at this point. Once again, shim for proper height and to align so that it is perfectly plumb with the adjacent wall cabinet. Once face frames are flush, clamp, drill and screw together as previously described.

NOTE: AT THIS POINT, YOU MAY WANT TO SET THE TALL CABINET INTO POSITION TO BE SURE IT FITS PROPERLY.

NOTE: REFER TO SPECIFIC INSTRUCTIONS THAT COME WITH SPECIALTY TALL CABINETS.

- 3.9** Once all cabinets are properly shimmed and properly positioned, finish tightening the screws to secure the cabinets to the walls.

- 3.10** Remove the support rails and spackle screw holes if needed.

⚠ WARNING

TO AVOID RISK OF DRIVING SCREWS BEYOND THE CABINET FACE, CARE MUST BE TAKEN TO PREVENT OVERTIGHTENING OF THE SCREWS AND DESTROYING THE INTEGRITY OF THE HANGING STRIP.

TO REDUCE THE RISK OF SERIOUS INJURY OR DAMAGE FROM A LOOSE OR FALLING CABINET, WALL CABINETS GREATER THAN 12" IN DEPTH OR LARGER THAN 24" IN WIDTH MUST NOT BE INSTALLED AND/OR USED AS SINGLE, STAND-ALONE CABINETS WITHOUT TAKING EXTRA PRECAUTIONS TO FULLY AND SAFELY SECURE THE CABINET TO THE WALL. ADDITIONAL MOUNTING SUPPORT INTO A CEILING, BULKHEAD, OR SIDE WALL(S) IS ALSO RECOMMENDED WHEN POSSIBLE. WHEN THIS IS NOT POSSIBLE, THEN ADDITIONAL SUPPORT MUST BE PROVIDED EITHER ABOVE OR BELOW THE CABINET TO SUPPORT WEIGHT AT A POINT AT LEAST 12" FROM THE WALL. THIS CAN BE DONE THROUGH ANGLE BRACKETS/BRACING, SHELVING, AND/OR ADDITIONAL CABINETS AS A STAND.

Step 4 Install Fillers (where applicable)

Fillers may be necessary when installing cabinets. They help allow for odd dimensions between a run of cabinets and the wall. They also allow clearance for doors and drawers to operate properly when turning a corner with a blind corner cabinet. Fillers and valances often have to be trimmed to fit.

- 4.1** Measure the area requiring a filler piece. Carefully trim the filler piece to the appropriate width with a saw.
- 4.2** Clamp the filler in place and once again, drill a pilot hole on the hinge side of the face frame and into the filler.
- 4.3** Fasten the filler to the cabinet with #8 x $2\frac{1}{2}$ " frame attachment (trim head) screws. (Figure 13)
- 4.4** If using a blind corner base, secure the other end of the filler through the inside of the cabinet with the same pilot hole and frame attachment screw technique.

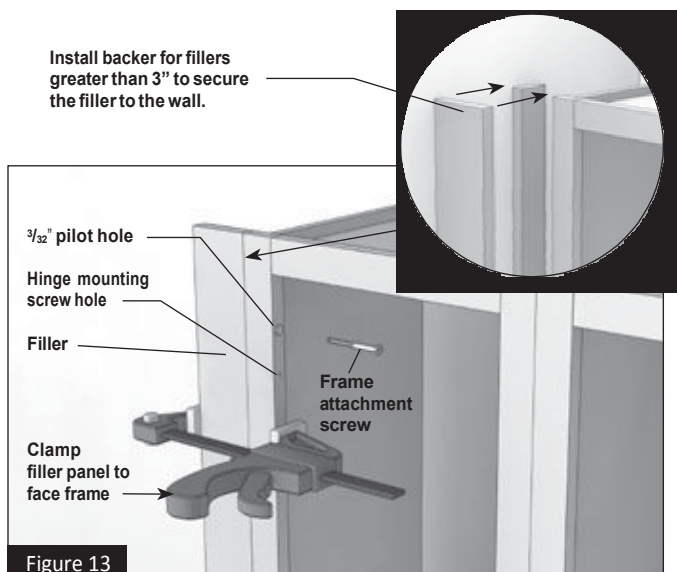

Step 5 Install End Panels (where applicable)

⚠ WARNING

TO REDUCE THE RISK OF DEATH OR SERIOUS PERSONAL INJURY OR PROPERTY DAMAGE, AVOID ANY CONTACT WITH PLUMBING, WIRING OR GAS LINES. THESE LINES ARE OFTEN IN THE WALLS AND UNDER THE FLOOR.

End panels are used to finish off a run of cabinets or box out an appliance. Make sure to install plumb and level.

5.1 If your application uses a finished end panel, first trim the panel to fit and then attach the panel to the side of the cabinet. This can be done with contact adhesive or $\frac{1}{2}$ " finishing nails. (Figure 14)

5.2 When installing a refrigerator or dishwasher return, it is important to mount a cleat at the floor to secure this panel. Simply cut a piece of 1x2 dimensional lumber about 20" long so it is not exposed at the front of the panel. Then secure to the floor with 2–3 fasteners (concrete screws for concrete floors / wood screws for wood floors). Secure the cleat to the panel (DWR, RR, SFR, etc.) with 2–3 wood screws. (Figure 15)

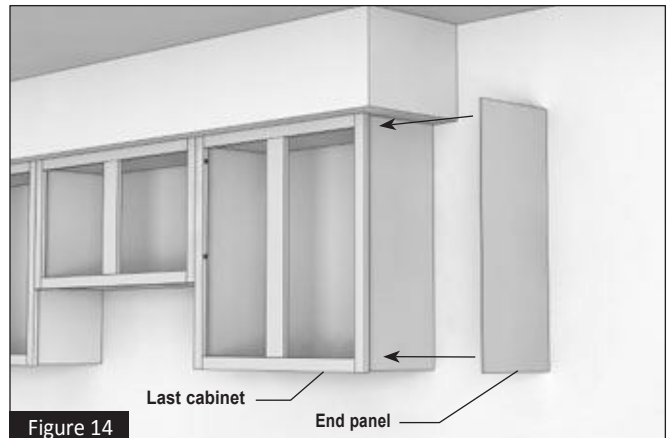

Figure 14

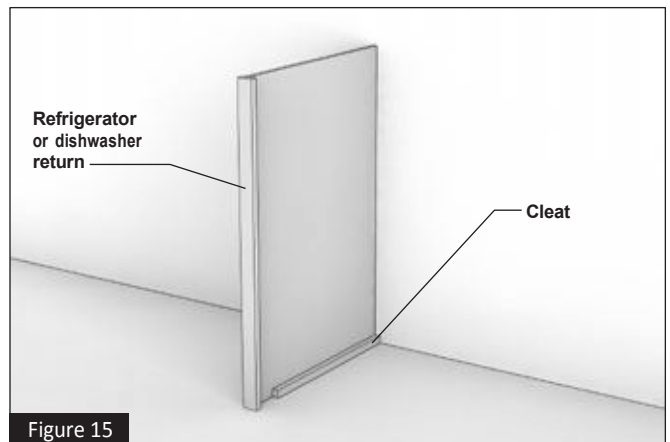

Figure 15

Step 6 Install Base Cabinets

Installing base cabinets is very similar to the wall cabinets above. The idea again is to lay out all the cabinets in position and make sure all cabinets are level, square and plumb.

6.1 Remove all shelves, drawers and doors. You might want to mark (or stack them in position) for reinstalling later. This will make the cabinets lighter and easier to handle. (See Appendix for drawer removal technique.) (Figure 16)

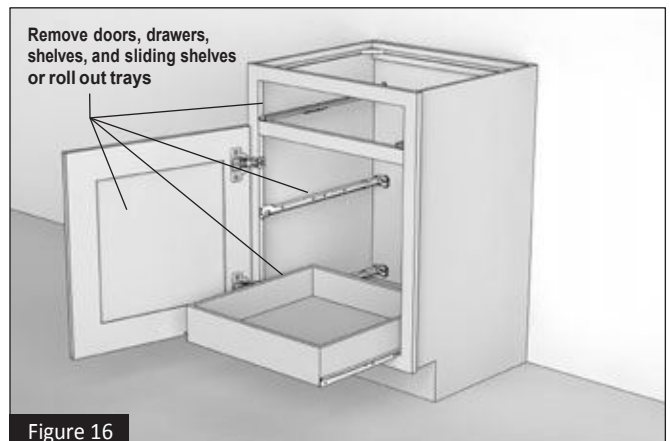
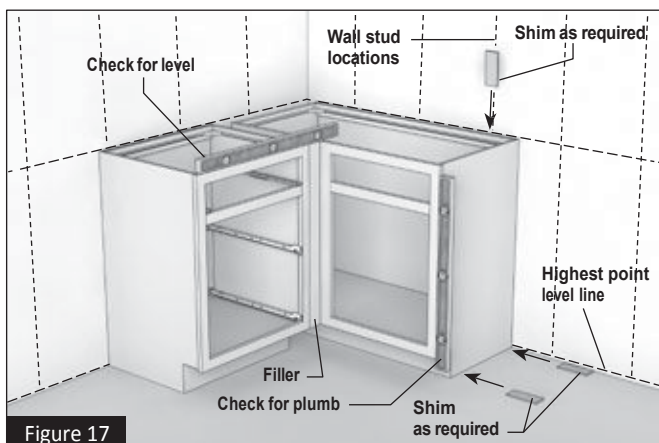

Figure 16

Continued

6.2 Start with the corner cabinet (if there is one) and place it in position where it is to be mounted. When using a blind base cabinet, make sure the cabinet is pulled out from the corner the appropriate distance as called for in your kitchen plan. (Figure 17)



NOTE: A BLIND BASE CABINET FILLS THE VOID OF THE CORNER WITH USABLE STORAGE. THE DOOR COMES PRE-MOUNTED ON THE LEFT SIDE, BUT CAN BE MOVED TO THE RIGHT DEPENDING ON YOUR DESIGN (SEE DIAGRAM B).

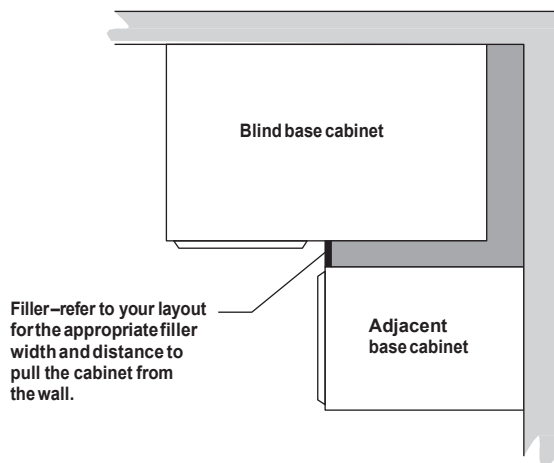

DIAGRAM B

6.3 Make sure your cabinet reaches the $34\frac{1}{2}$ " high level line you drew on the wall. If not, you may have to shim into position or use scrap to raise it to the proper level. If the cabinet is tilting backward, shims at the back edge will help. If it's tilting forward, use the pry bar under the front to adjust and then shim.

6.4 Measure from the corner to the first stud mark and transfer the measurement to the inside of the cabinet to be installed. Repeat this step for each and every stud. Now drill $\frac{7}{32}$ " mounting holes through the center of the hanging rail inside of the cabinet.

6.5 Fasten the cabinet to the wall with #10 x $2\frac{1}{2}$ " wall attachment (pan head) screws.

6.6 If there is a blind corner cabinet, seal the opening with the $\frac{1}{8}$ " panel packed inside the cabinet, as previously described in the wall cabinet installation section.

6.7 Next, shim the adjacent cabinet into position and check for level and plumb. Once again, clamp the face frames when they are perfectly flush, drill pilot holes and join the two cabinets with screws as previously described.

6.8 Continue this process until all cabinets are in place, making sure that each cabinet is resting at the line on the wall, level and plumb with each adjacent cabinet. Also make sure to screw cabinets to each other at the face frames before screwing to the wall. (Figure 18)

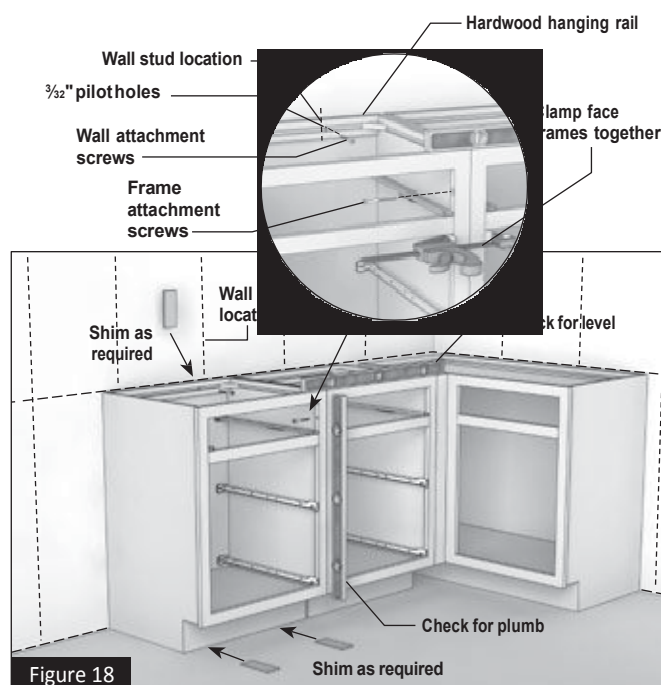

6.9 The final step is adding fillers between the last cabinet and the wall. Reference the layout provided by your designer for location and dimension.

NOTE: YOU MAY NEED TO CREATE CUTOUTS FOR PLUMBING AND ELECTRICAL JUNCTION BOXES. BE SURE TO MEASURE AND MARK ACCURATELY. CUT HOLES FROM THE BACK OF THE CABINET BEFORE MOUNTING TO THE WALL.

Step 7

Install Moldings (if applicable)

NOTE: CROWN MOLDINGS AND OTHER TRIM MAKE ANY KITCHEN LOOK CUSTOM BUILT. IF YOU ARE NOT AN EXPERIENCED CARPENTER, THIS MAY BE DIFFICULT AND BETTER LEFT TO THE PROS. BUT IF YOU HAVE MADE THE DECISION TO DO-IT-YOURSELF, YOU MAY WANT TO PRACTICE YOUR MITER CUTS ON INEXPENSIVE PIECES OF MOLDING FROM YOUR HARDWARE STORE.

- 7.1** Trim molding is used to trim out cabinetry where cabinets meet an adjacent wall, soffit or ceiling. Carefully measure and cut to proper length. Use small finish nails or a pin nailer to attach where cabinet and wall meet. (Figure 19)

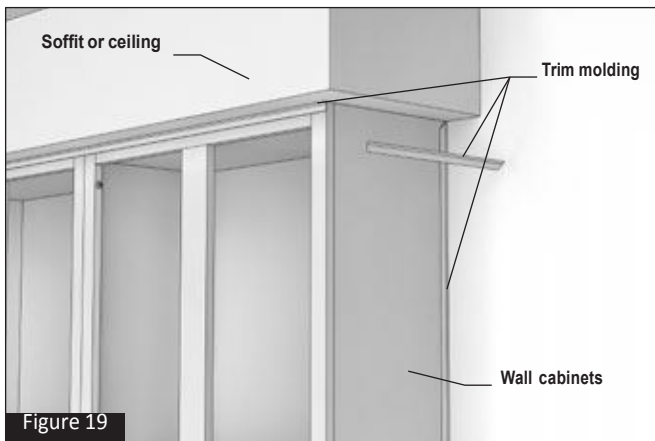

- 7.2** Crown moldings mount along the top edge of the cabinets. If your cabinets are full overlay, you may need to install some blocking material to the top of the cabinet first. (Figure 20)

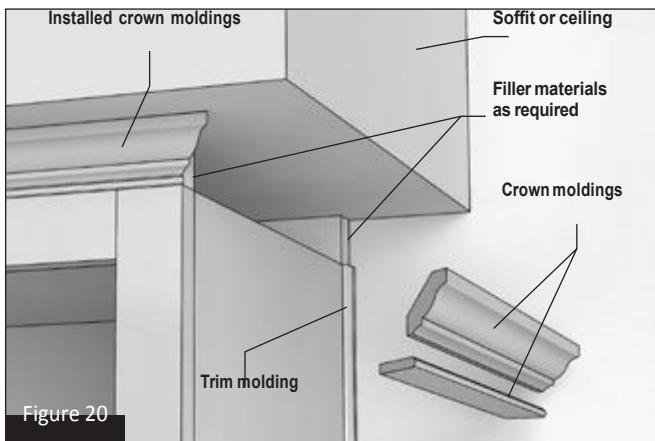

- 7.3** When moldings meet at an angle, you will need to use a miter box for a proper cut. Once moldings are cut to fit, use small finish nails or a pin nailer to attach the molding to the face frame of the cabinet.

- 7.4** When trimming molding, keep in mind that the proper position for the molding in the miter box is upside down with the bottom edge resting against the fence. (Figure 21)

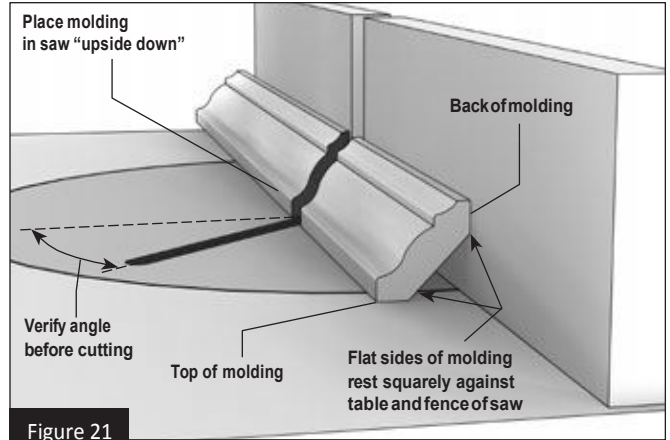

NOTE: ALWAYS USE A MITER BOX FOR ACCURATE MOLDING CUTS AND DOUBLE CHECK THE ANGLE REQUIRED BEFORE CUTTING. SEE DIAGRAMS C-G ON PAGES 12-13 FOR A HANDY GUIDE.

Continued

DIAGRAM C: MITER CUTS FOR 90° ANGLES

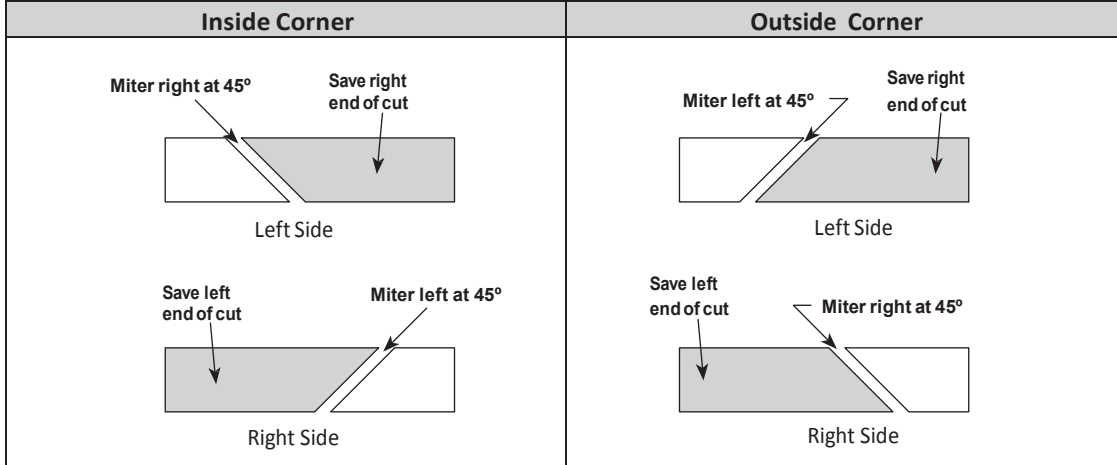

DIAGRAM D: MITER CUTS FOR 135° ANGLES

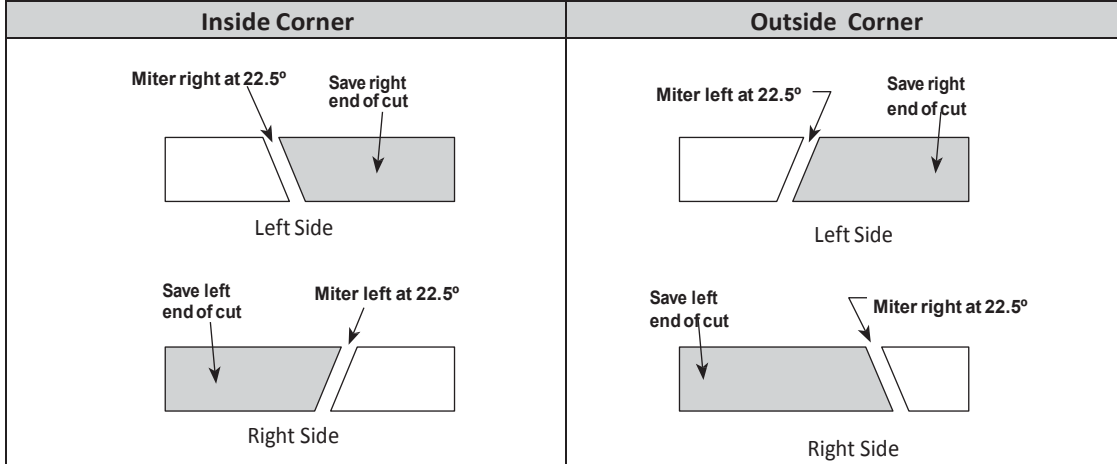
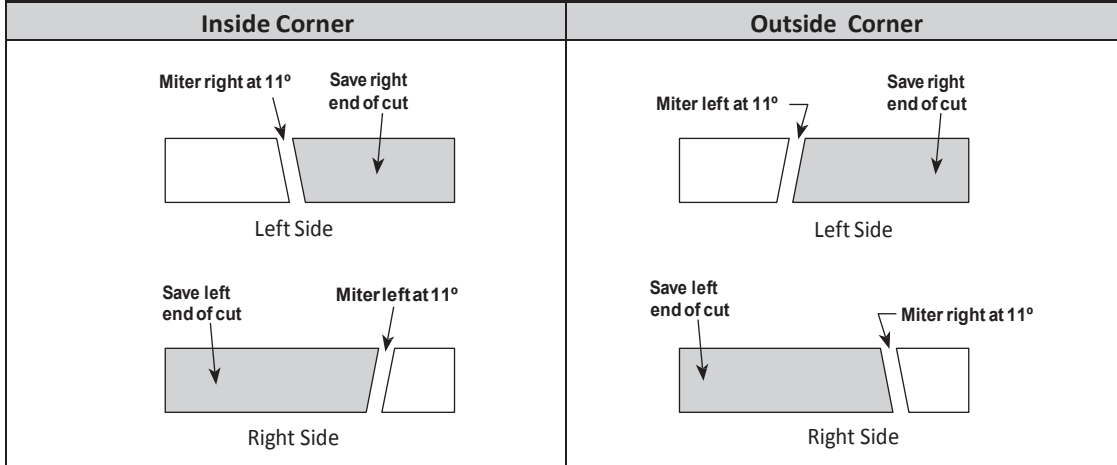

DIAGRAM E: MITER CUTS FOR 158° ANGLES



MOLDING CUTS

90° ANGLES: CUT MOLDING AT 45° ANGLE

135° ANGLES: CUT MOLDING AT 22.5° ANGLE

158° ANGLES: CUT MOLDING AT AN 11° ANGLE

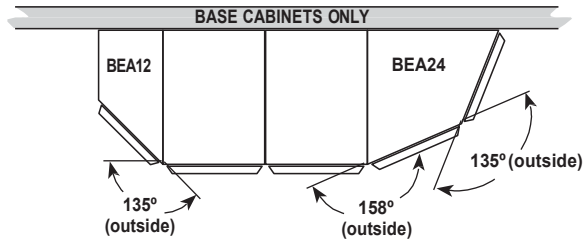

DIAGRAM F

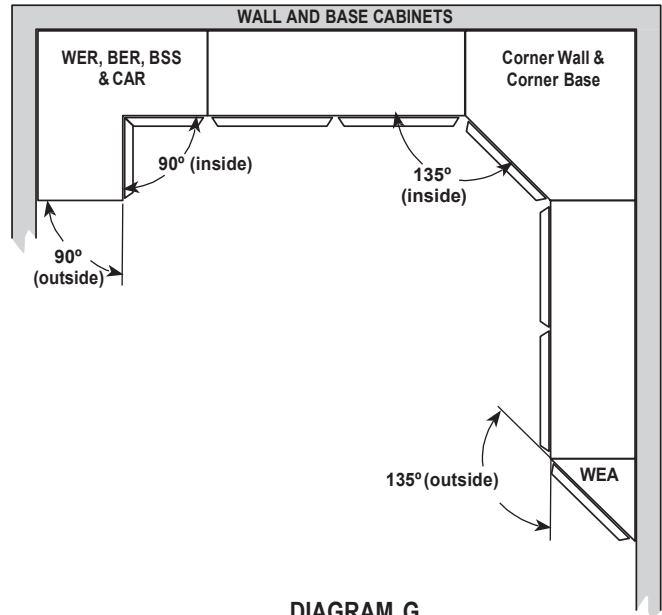

DIAGRAM G

Step 8 Final Assembly and Cleanup

8.1 Once all cabinets are hung, leveled and screws are tightened, it is helpful to sweep out or vacuum any debris or sawdust.

8.2 Install shelves by placing the shelf supports into the holes on both sides of the cabinet, push in completely and turn until the flat side rests upward and place the shelves into position. On wide cabinets, you will also need to insert a shelf rest on the back wall and front stile of the cabinet for added stability using the kit enclosed with the cabinet. (Figure 22)

8.3 Install any interior convenience kits, such as tray dividers, rolling shelves, wastebaskets, etc. See instructions with each kit.

8.4 Install the toe kick overlay along the bottom of the base cabinets. Simply measure a continuous run of base cabinets and cut a piece of toe kick to that length and adhere with adhesive caulk and pin nails spaced about 24 inches apart.

Reattach doors by replacing the screws through the hinges.

Insert drawers into the glides. (See Appendix for drawer install technique if necessary.)

Remove the wall support rail and fill the screw holes with spackling. The wall is now ready for your backsplash material.

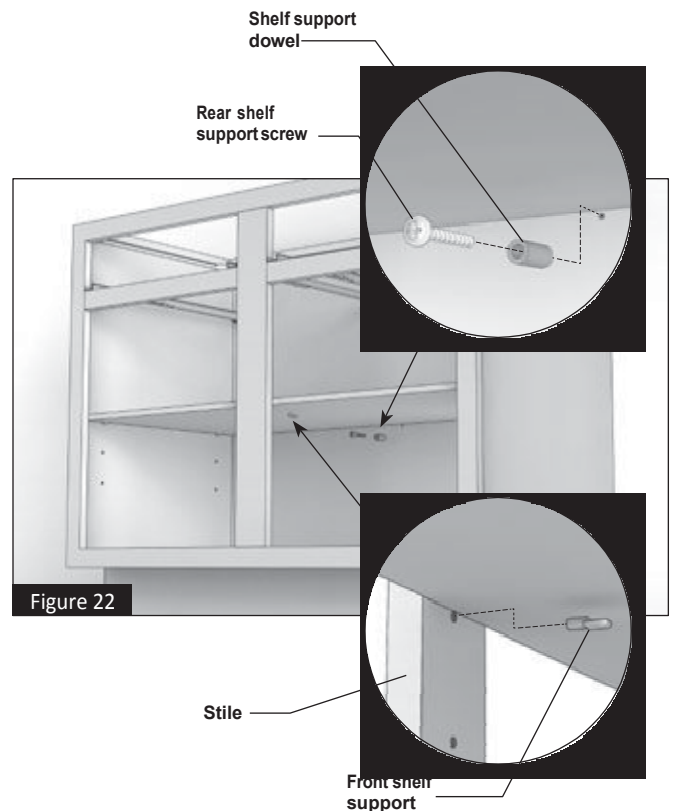

Figure 22

The Finishing Touches

Door Hinge Adjustment

All hinges come pre-set from the factory. But occasionally, other adjustments are needed to straighten cocked doors or doors that don't seem to sit flush. This is easily accomplished with just a screwdriver. The hinges on the back of the door have adjustment screws. With a little experimentation, you will see which screw moves the door the way you need it to go.

Sometimes one door is mounted higher than its neighbor. A simple measurement can confirm this. Check along one edge or use a straight edge to determine if a correction is needed. (A level works great and can come in handy when making the adjustment.)

To adjust the higher door, simply open it and loosen the mounting screws that hold the hinges to the inside edge of the cabinet frame. There is a slot in the bracket so the door will slide down slightly. Retighten the hinges to the frame so that the door aligns with the other, checking with the level. (Figure 23)

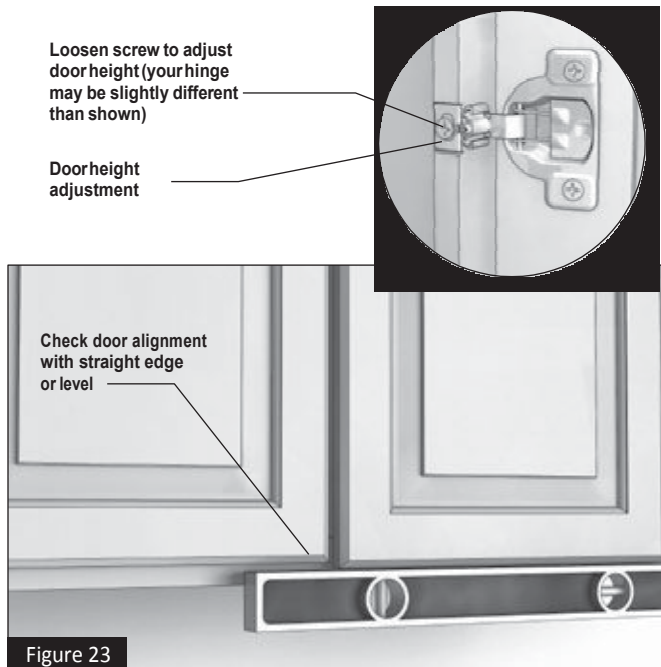

Drawer Head Adjustment

Square up drawer front (if necessary). Check it visually and use a rule to size up the differences. Then loosen one side by unscrewing the drawer front slightly. Use the rule to help you determine how high to raise the lower side. Then, while holding the drawer front in place, tighten down the screws again. (Figure 24)

Attach hardware after careful measuring. Use your drill to make pilot holes and install hardware with screws supplied. To prevent screw heads used for door hardware from scratching face frames, you may want to countersink screw heads so they can't strike the face frame.

NOTE: JIG/TEMPLATES ARE USUALLY AVAILABLE WHERE HARDWARE IS SOLD, AND MAY BE USEFUL FOR ACCURATE HARDWARE INSTALLATION.

Once all assembly and adjustments are done, carefully examine your cabinets for any scratches or nicks that may have occurred during the installation process. Follow the handy guide for touching up and cleaning your cabinets found in the Appendix on page 16.

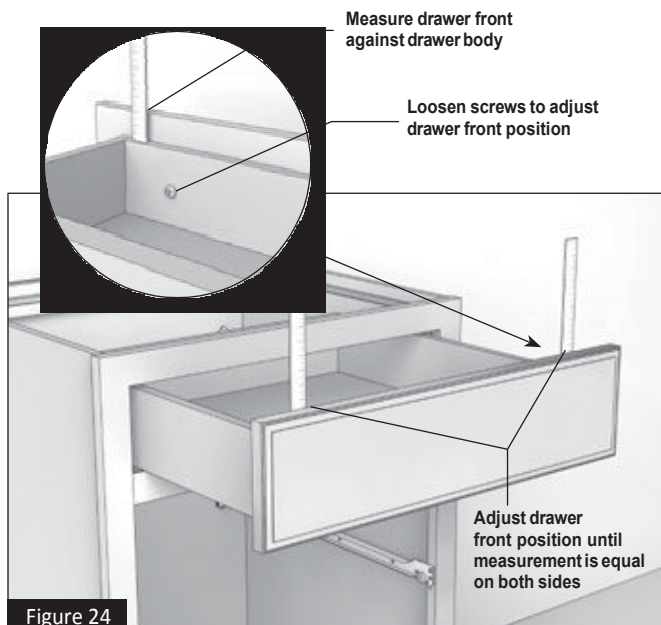

Drawer Installation

To install drawers with Full Access Hidden Glides, extend each drawer glide. Place the drawer on top of the extended drawer glides. Slide the drawer squarely into cabinet on top of drawer glides until you begin to feel resistance.

Push drawer evenly with moderate pressure until you hear the clips snap into place. Pull drawer open to verify that both clips have snapped into place. If you find that a clip is not in place remove the drawer and repeat the installation procedure.

To install drawers with side-mounted drawer glides, place the drawer in the cabinet opening, aligning the rollers on the track. Push the drawer into the cabinet opening.

Drawer Glide Adjustments

Cycle the drawer open and closed to ensure that it operates smoothly. If the drawer is not operating smoothly, be sure that hooks on both of the drawer glides are engaged into the holes in the back of the drawer. (Figure 25)

If the drawer still does not operate smoothly, open the drawer and take a closer look at the drawer glides mounted inside the cabinet. Slide the glides toward the center at the rear of the cabinet. Then slide the drawer all the way in. This is usually all it takes to correct the alignment and get a smoother glide. Adjust the back of the glides by removing the drawer and sliding the back of the glide left or right if more adjustment is necessary. (Figure 26)

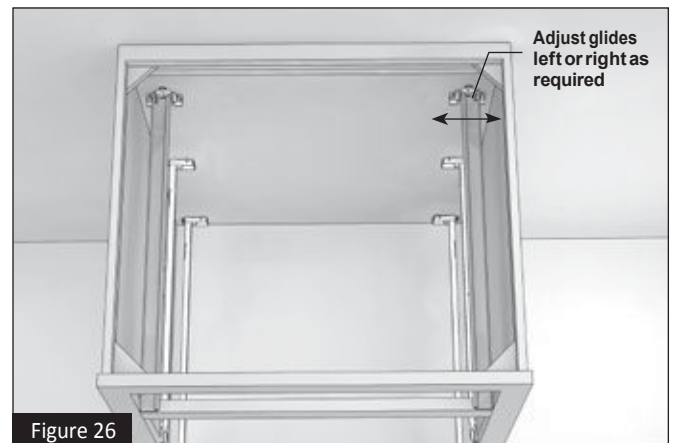
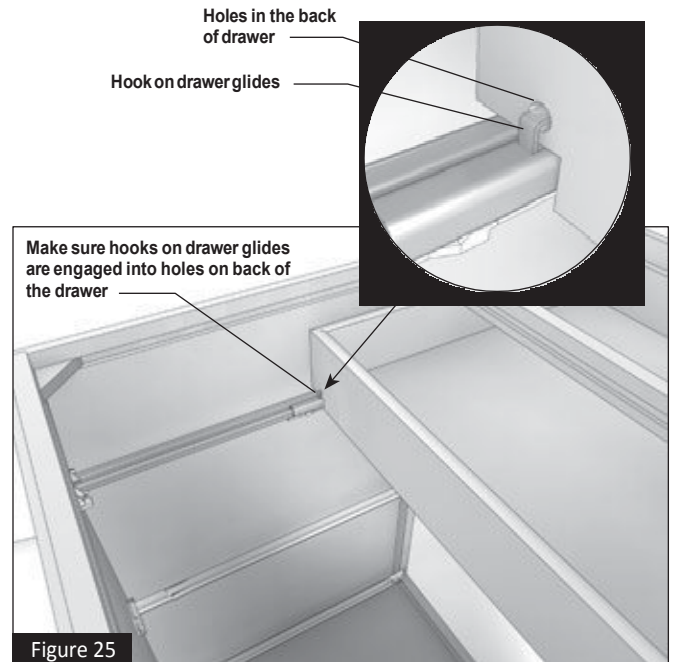

Handy Pointers

Drawer Removal

To remove drawers with Full Access Hidden Glides, locate the black plastic clips on the bottom of the drawer. Grasp clips at the finger points provided. Using moderate pressure squeeze the handles on both sides. This pressure should be maintained during drawer removal. While continuing to squeeze the black clips, pull the drawer straight out until it is removed completely. (Figure 27)

To remove drawers with side-mounted drawer glides, pull the drawer straight out until it stops. Then lift the front of the drawer slightly and gently pull forward until the glides release.

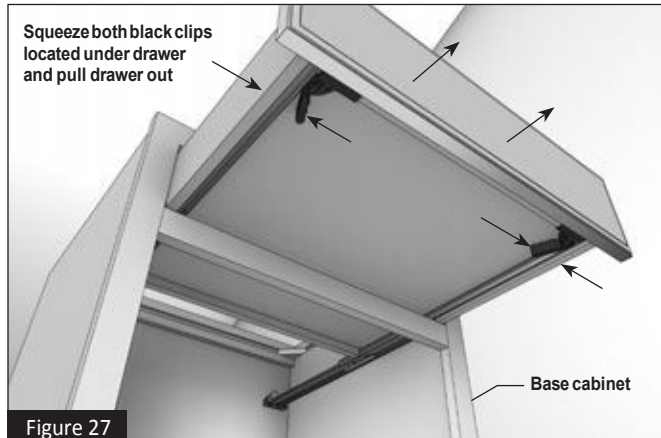

Figure 27

Care and Cleaning

Our cabinets are extremely resistant to stains and surface damage that can be caused by common household chemicals. They exceed industry standards in resisting stains like coffee, grape juice and moisture—all common in any kitchen. But this doesn't mean that they are impervious to damage through neglect.

Clean spills immediately. Use a clean cloth and mild soap if necessary. Wipe dry with a soft cloth. Do not use bleach, detergents, citrus or ammonia based cleaners, steel wool, soap pads or abrasive cleaners on your cabinets.

Periodically, remove dust from cabinets with a soft lint-free cloth. The cloth may be slightly dampened with water or a spray type dust remover. Wood and laminate cabinet surfaces may be polished once every few months with a high quality, non-oil based furniture polish. Do not use a paste wax type material. Wax build-up is difficult to remove and will leave a residue that attracts dust and moisture. Polishes containing silicon should not be used.

Extra care should be taken that cabinet finishes are not exposed to heat in excess of 200 degrees Fahrenheit (174 degrees for Thermo Foil finishes).

Heat shield kits are available for Thermo Foil styles to direct heat from ovens away from adjacent cabinets.

To touch up scratches and nicks that may occur during the installation process or during the life of your cabinets, use the stain touch-up marker and Fil-Stik included in the sink base. The touch-up marker and Fil-Stik are matched to the finish of your cabinetry and created especially for do-it-yourself repairs.

Use the touch-up marker on surface scratches, scuffs or rubbed edges. Simply shake the marker; remove cap and press down on the tip until the felt is wet. You may find it easier to test this on paper or cardboard first. Apply color touch-up with light strokes and use a cloth to immediately wipe off any excess. Allow to dry for several minutes.

The Fil-Stik is the tool of choice for chips, dents, deep scratches or open joints. Simply rub across the affected area until it is filled and wipe off the excess with a dry cloth. The touch-up Fil-Stik will fill small holes, chips, dents or open joints. Keep the Fil-Stik out of reach of children and pets.

These extra steps will ensure that your hard work looks its best and will help your cabinetry look great for years to come.

WE PROVIDE THESE INSTRUCTIONS ON AN "AS IS" BASIS AND
DISCLAIMS ANY AND ALL LIABILITY FOR ANY INACCURACIES,
OMISSIONS OR TYPOGRAPHICAL ERRORS CAUSED BY THE
USER'S EQUIPMENT OR BY ANY THIRD PARTY'S EQUIPMENT.